



**Unique
moments**

Unique moments

Yes, life is in the little things.

In those fleeting, unique and unrepeatable moments. They happen right there, at home, at work, in a hotel or in a restaurant; in all those settings where you create your personal collage of little stories.

Enjoying each and every one of those scenes, on your terms, is what authentic “intense living” is all about. At RS Barcelona it gives us a real buzz to create products that accompany you in your everyday experiences, that form part of those moments which may fly by but which stay with you forever.

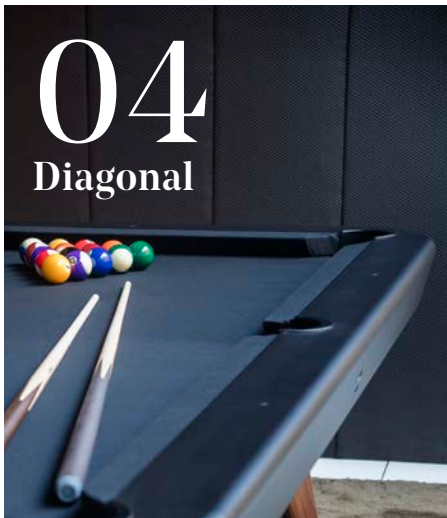

04
Diagonal



18
RS#Ping Pong



22
Football tables

28
RS#Dining



10
You and Me

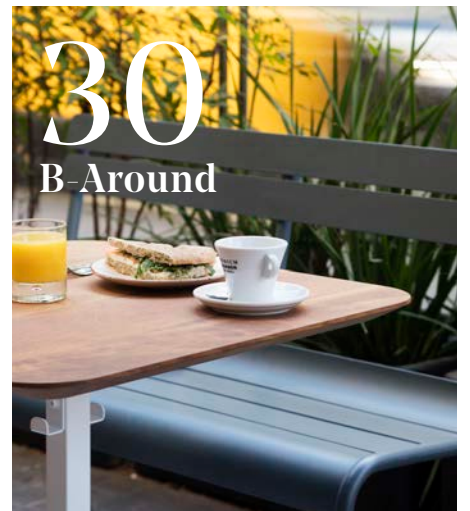

30
B Around

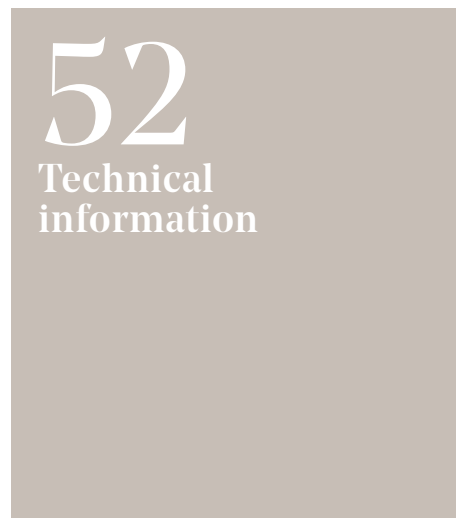
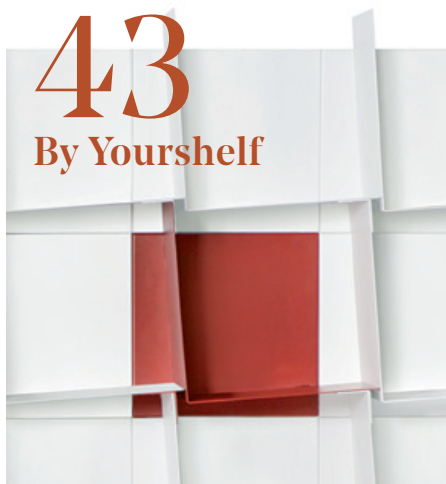



Diagonal pool table — p. 53

Diagonal —

A pleasant setting. Great company. And good music. Fancy a drink? This moment has your name and that of the Diagonal pool table all over it.





Diagonal pool table — p. 53



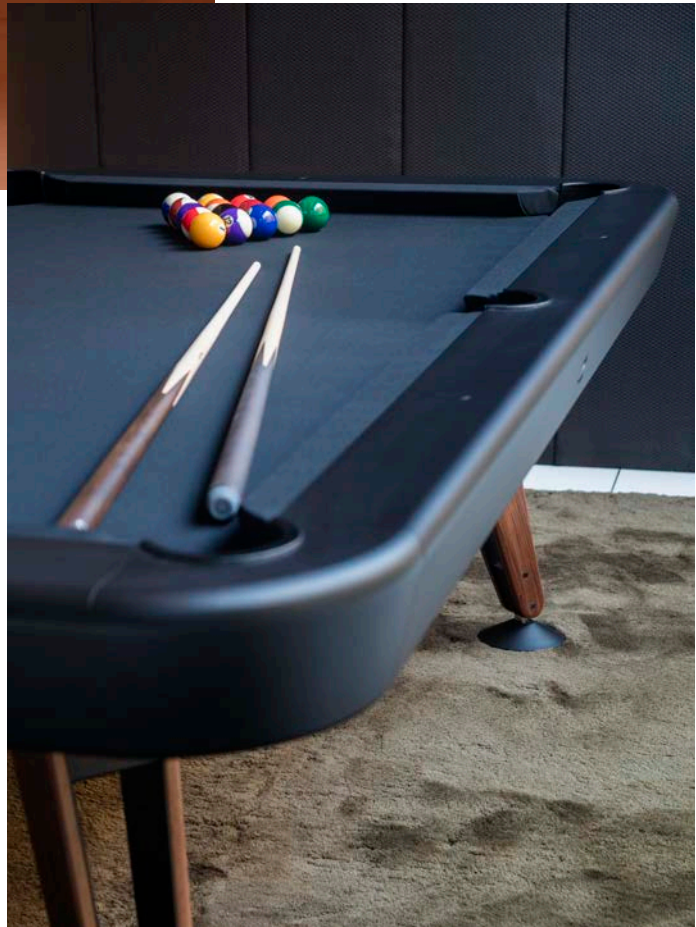



Diagonal pool table — p. 53



You and Me collection — p. 55-58

You and Me —
The You and Me
ping-pong table contains
all the moments
you can imagine.

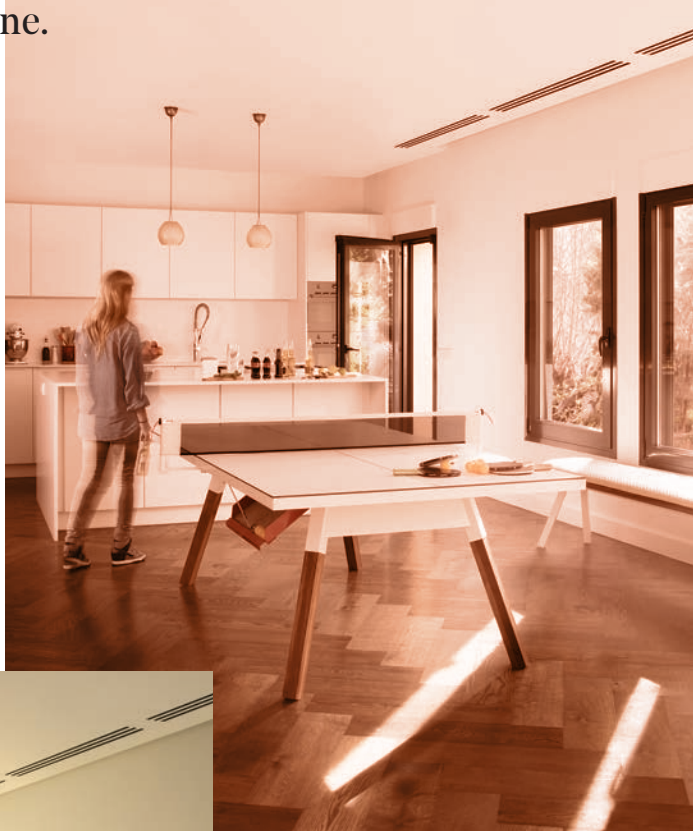





You and Me collection — p. 55-58



You and Me table — p. 55-58

A photograph of an outdoor dining area. In the foreground, a black rectangular table is set with several dishes of food, including a white plate with red meat, a glass bowl, and a white plate with bread. There are also bottles of beer on the table. The table is surrounded by wooden benches with black metal legs and grey cushions. Above the table, a black metal pergola structure is visible, with two large green pendant lights hanging from it. In the background, there is a stone wall with a staircase on the left and a wall covered in green vines on the right. The ground is covered in gravel and fallen leaves.

The **You and Me** collection is an invitation to go al fresco and enjoy the nice weather.



You and Me table — p. 55 / By Yourshelf shelving — p. 69

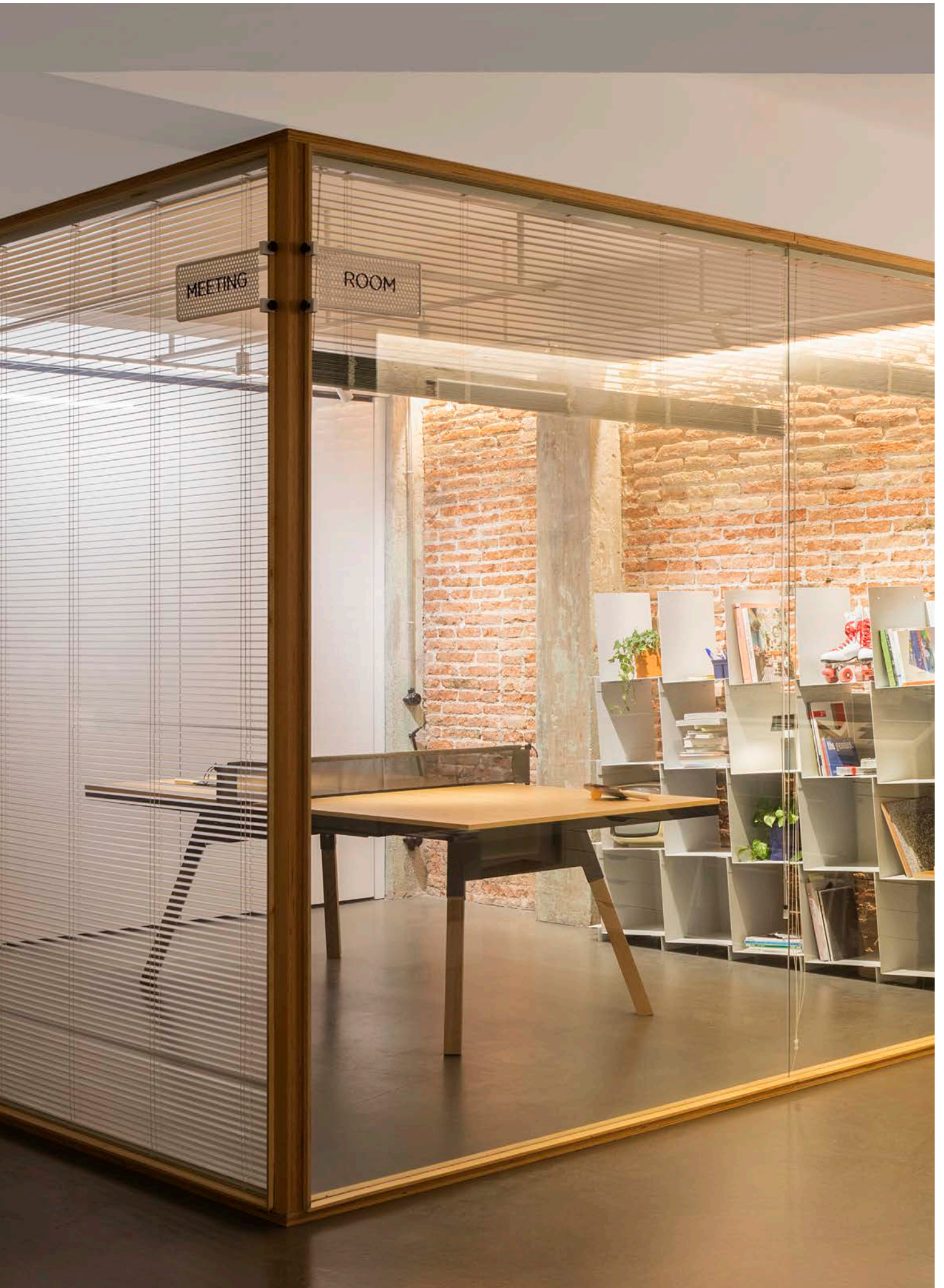



RS#Ping Pong folding — p. 59



RS#Ping Pong —
The folding version of the
RS#Ping-Pong remains
discreetly tucked away
until it's unfolded,
revealing all its charm.





You and Me bench — p. 56 / RS# Ping-Pong stationary — p. 59 / RS#3 Wood football table — p. 61





RS#2 football table — p. 60

Football tables —

It all starts with “Shall we have a game?” A football table turns any space into a very playful place. Some win; others lose. But you all have fun.





RS#3 Wood football table — p. 61



RS#3 football table — p. 62 / Wall Champions hanger — p. 70 / Eiffel stool — p. 72

RS#3 football table — p. 61 / Ombra stool — p. 67





RS#2 football table — p. 60

RS#Dining —
Gastronomy and playtime
have met up for a bite
to eat and they're sharing
the most original table
in the restaurant.



Chef José Andrés' Jaleo Restaurant in Washington D.C.







B-Around table — p. 66

B-Around —

No two workdays are the same.
No two projects are the same.
Likewise for meetings. Not even
two B-Around tables are the
same. You make yours unique.





B-Around table — p. 66 / You and Me bench — p. 56 / Ombra stool — p. 67

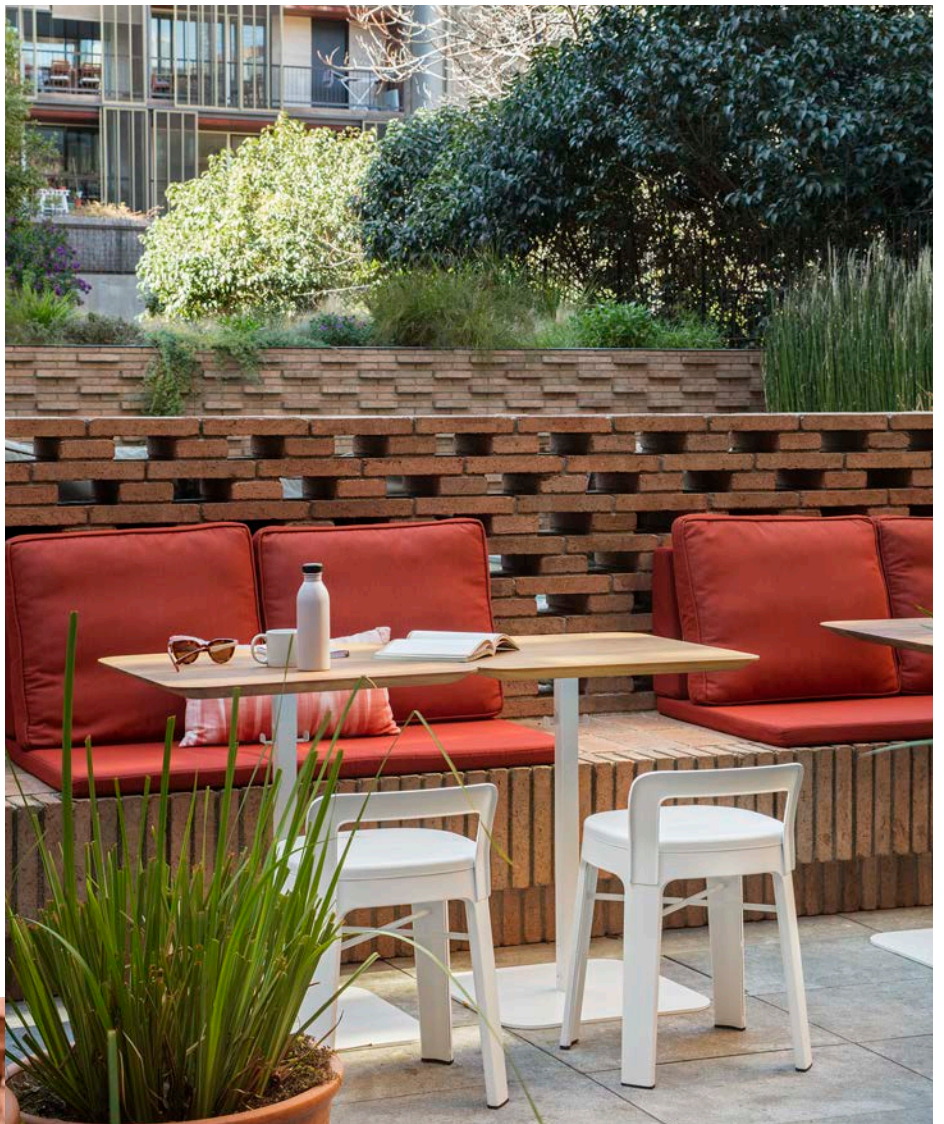

Ombra —
Versatile, always blending in
and always faithful to your
ideas. Ombra will be there
for whatever you need.

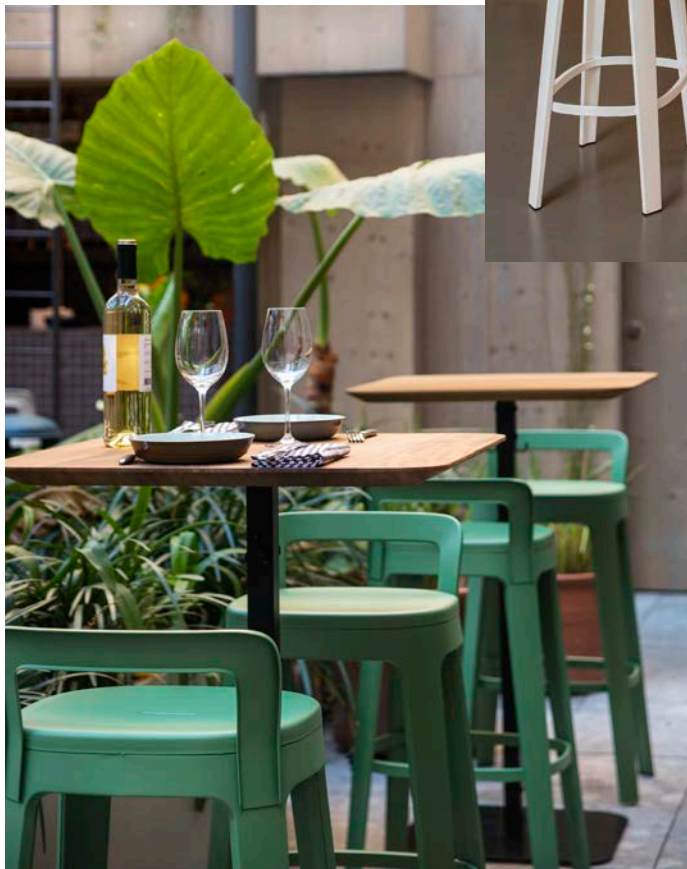
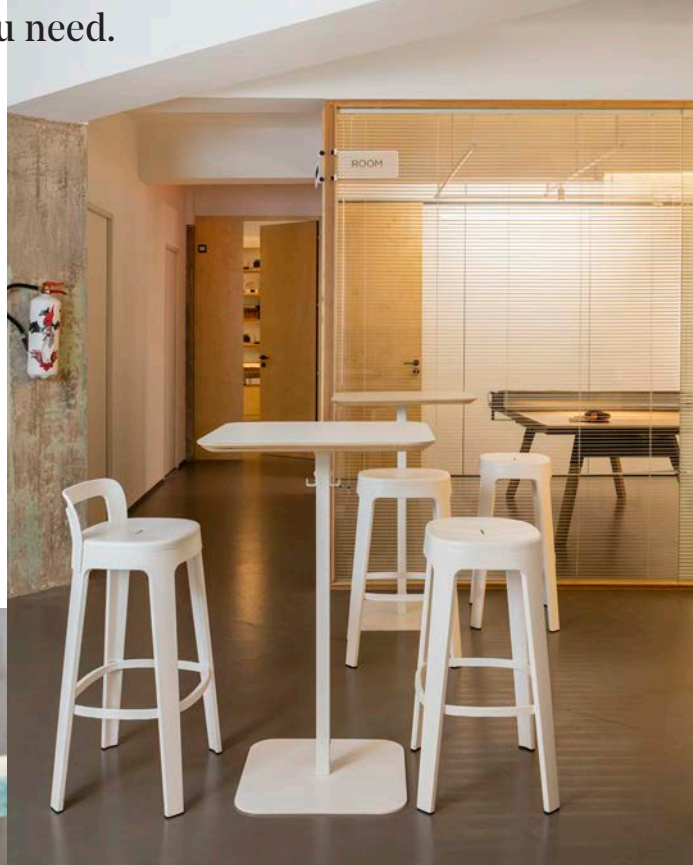

B-Around table — p. 66 / Ombra stool — p. 67

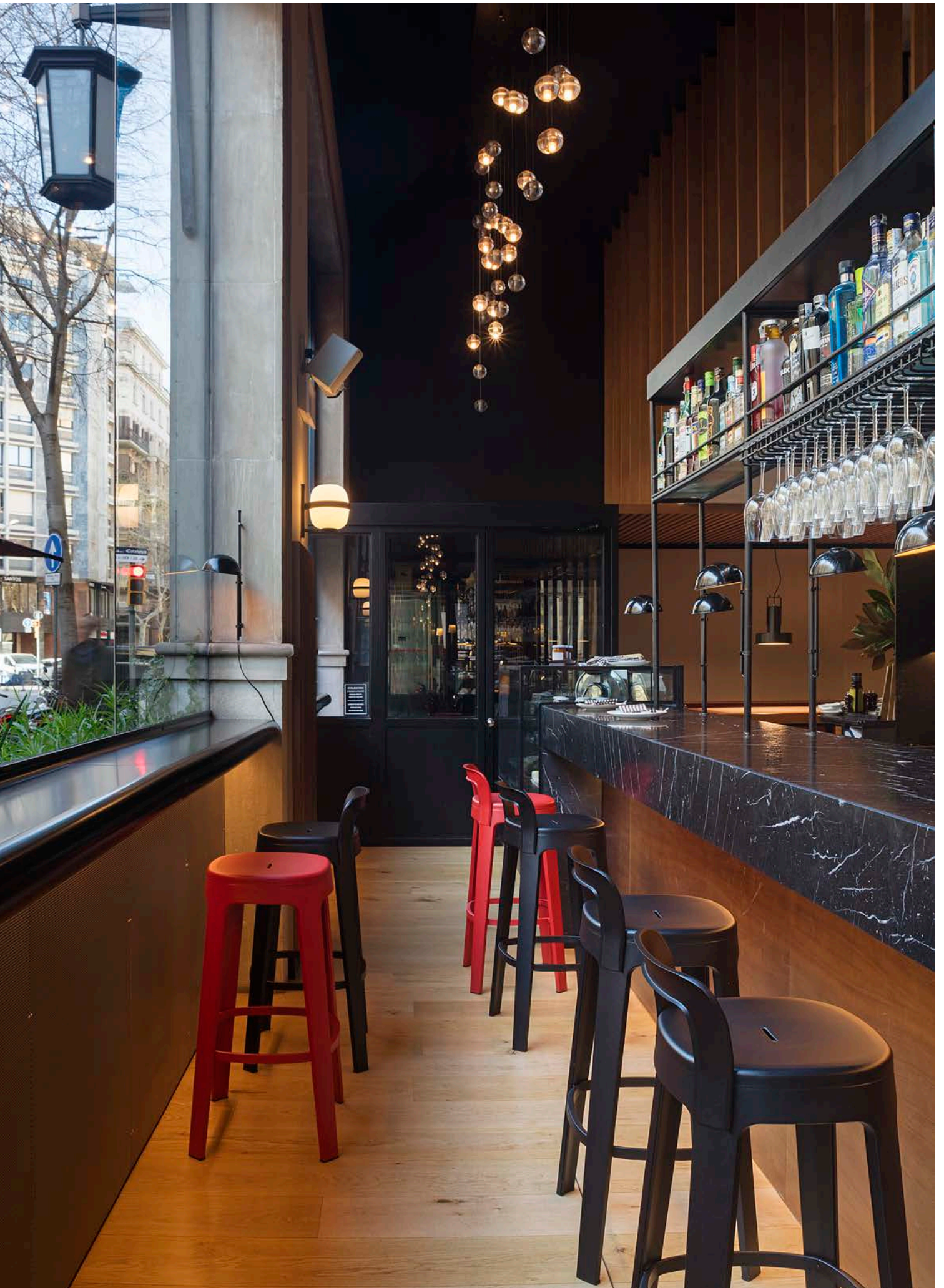





Ombra stool — p. 67



On the Road bench — p. 69



On the Road —

It says that any corner will do; it doesn't want to be the centre of attention. That's what the On the Road bench is like. Being yourself is all you need to feel free.





Plec table — p. 68

Plec —

A table that takes the shape of a 5-minute coffee break; of a few pages of the book you're reading; of an informal meeting on the terrace.

What shape can you see in it?



Plec table — p. 68



Plec table — p. 68

By Yourshelf —
You enjoy creating your own stories, questioning stereotypes, rejecting the status quo. By Yourshelf is the shelf you build to your taste, module by module.

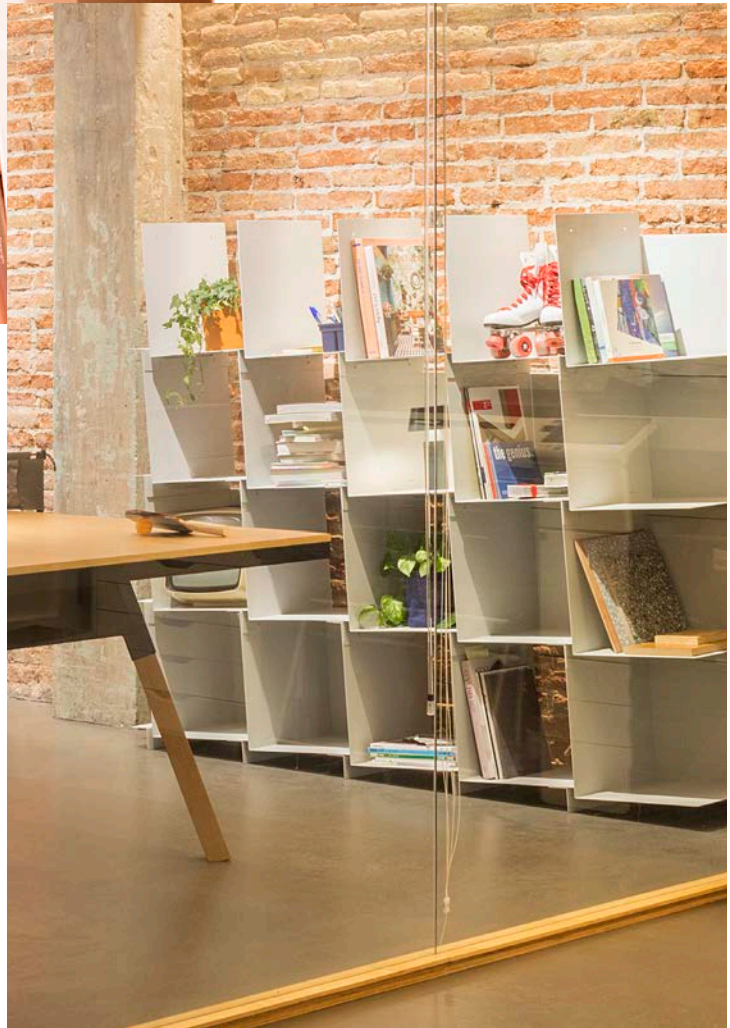

By Yourshelf shelving — p. 69 / You and Me table — p. 55

Eiffel —

A stool inspired by Paris,
designed in Tokyo and
produced in Barcelona.
Its next destination
is up to you.



Eiffel paper stool — p. 73

Eiffel aluminium stool — p. 72 / Plec table — p. 68



Wall Champions —
You can hang your jacket
on it but its main job is
to welcome you or see you
off with a smile.

Wall Champions hanger — p. 70

RS#4fun —

As the little ones grow up,
the fun won't get left behind.
When you need it to, RS#4fun
will shoot up as well.



The RS#4fun has three
different leg settings to adapt
to the players' height.

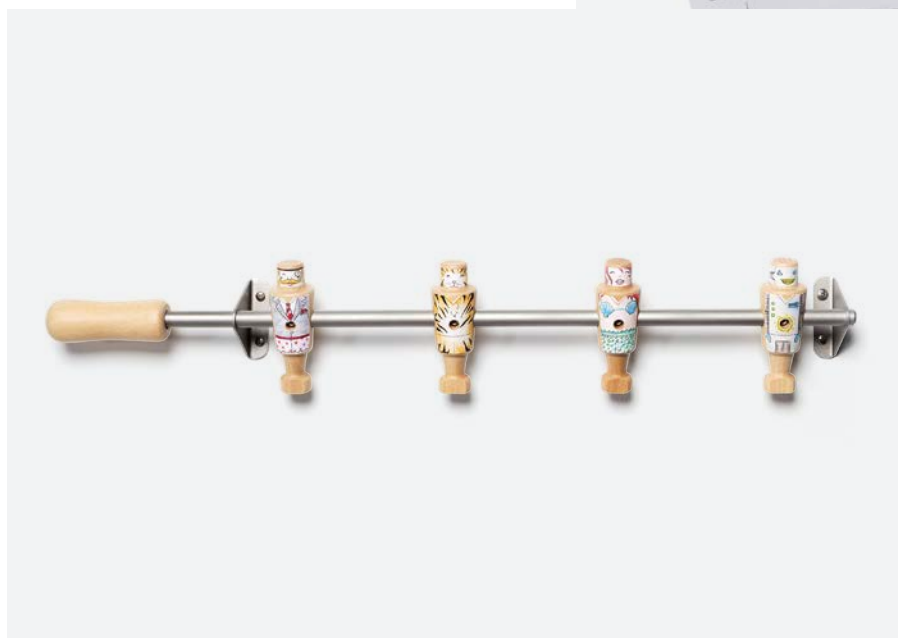
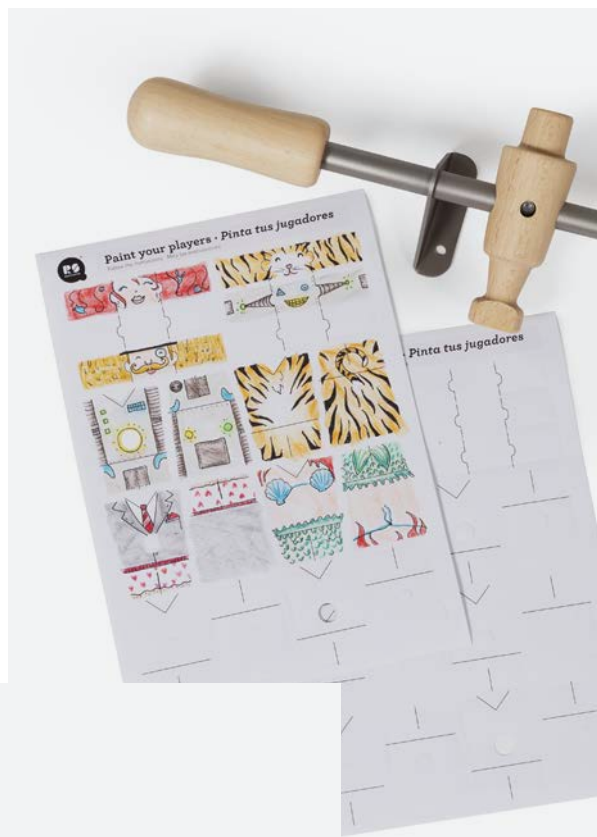

Wood Champions and RS#4fun come with stickers to customise your players

Wood Champions hanger — p. 71



Mon Oncle barbecue — p. 71

Mon Oncle —
An all-in-one portable
barbecue and vintage
suitcase in which to store
truly delicious moments.



Let's do something unique



Each product is the sum of unique moments. The fledgling idea. The first sketches. The countless test designs on paper. The magical encounter between industry and artisanship. Attention to detail.

And, to make it even more special, we can fully customise it for you. If you can imagine it, we can do it.

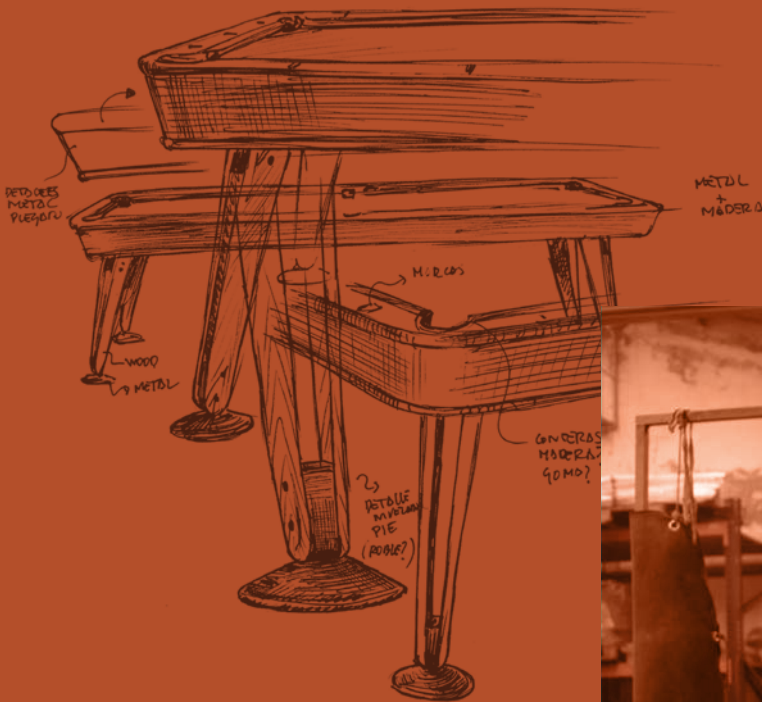

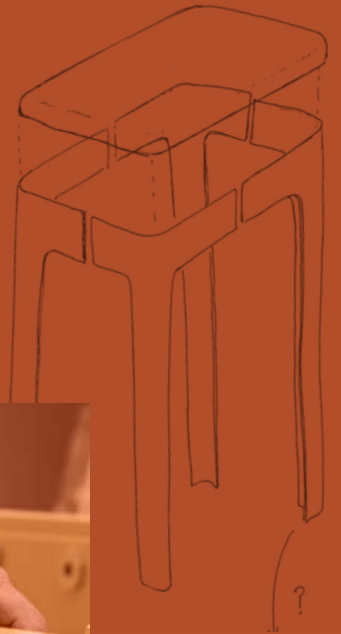
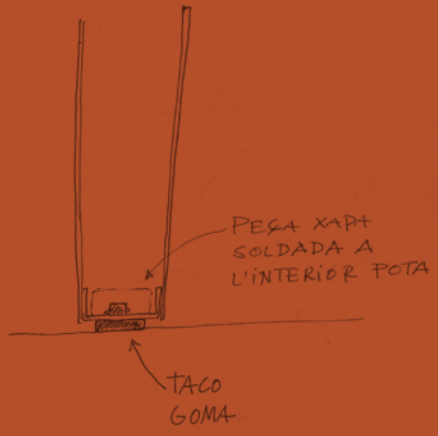

Technical information

Diagonal —	53
Diagonal Accessories -	54
You and Me collection —	55
RS#Ping-Pong —	59
Ping-Pong accessories —	59
RS#2 —	60
RS#3 Wood —	61
RS#3 —	61
RS#2 Gold —	62
RS#3 Wood Gold —	62
RS#2 Dining —	63
RS#3 Wood Dining —	65
RS# Players customisation —	65
Football table accessories —	65
B-Around —	66
Ombra —	67
Plec —	68
On the Road —	69
By Yourshelf —	69
Wall Champions —	70
Wood Champions —	71
Mon Oncle —	71
Eiffel —	72

DIAGONAL

BY YONOH, 2018



MATERIALS

Structure: Steel finished with a micro textured polyester paint.

Cloth: Gorina 90% worsted wool and 10% nylon.

Board: 20 mm thickness 1 piece fibre cement.

Legs: Steel with polyester paint and iroko. Walnut and oak wood available.

Cushion: K66 premium rubber cushion.

Structure



RAL9016



RAL9005



RAL3020



RAL5013



RAL6011

Cloth



GREY



BLACK



BURGUNDY



BLUE



GREEN

Legs



IROKO



WALNUT



OAK

AMERICAN 7 FEET



92.7 in / 235,5 cm

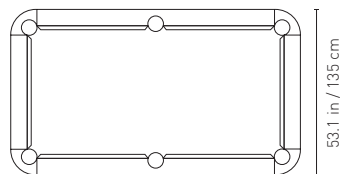

53.1 in / 135 cm

Playing area: 78.7x39.4 in / 200x100 cm

WEIGHT

430 lb / 195 kg

AMERICAN 8 FEET

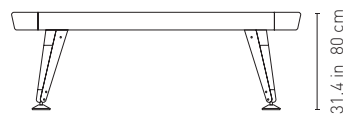

102.4 in / 260 cm

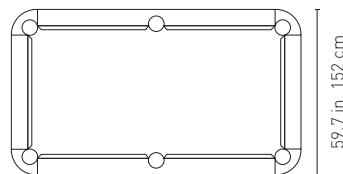

59.7 in / 152 cm

Playing area: 88.2x44.1 in / 224x112 cm

WEIGHT

474 lb / 215 kg

DIAGONAL COMES WITH:



16 BALLS

Aramith Premium pool set.



2 CUES

Dufferin club cue Canadian Maple.



1 TRIANGLE



12 BLACK CHALK MASTER



TABLE BRUSH

DIAGONAL ACCESSORIES

DIAGONAL FLOOR CUE RACK

BY YONOH, 2019



MATERIALS

Structure: Steel finished with a micro textured polyester paint.

Trays: Iroko, walnut or oak.

Includes: Wheels.

Balls, cues, black chalk, triangle and brush care included with Diagonal pool tables. Diagonal floor cue rack comes without accessories.

Structure



RAL9016



RAL9005



RAL3020



RAL5013



RAL6011

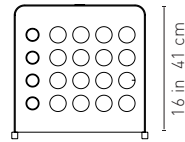
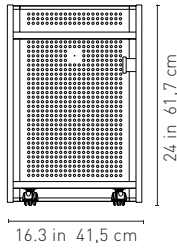

WEIGHT

33 lb / 15 kg

Trays



IROKO



WALNUT



OAK

DIAGONAL WOODEN TOP

RAFAEL RODRÍGUEZ, 2019



MATERIALS

Cross-ply and iroko, walnut or oak finish.

It comes in three pieces.

Finishes



IROKO



WALNUT



OAK

AMERICAN 7 FEET

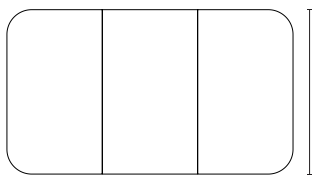

WEIGHT

55.1 lb / 25 kg

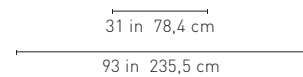

AMERICAN 8 FEET

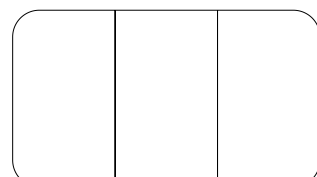

WEIGHT

77.2 lb / 35 kg

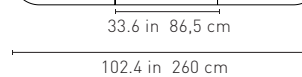

YOU AND ME COLLECTION

BY ANTONI PALLEJÀ OFFICE, 2013

INTERIOR DESIGN
BEST OF YEAR 2014



TABLES - INDOOR/OUTDOOR



MATERIALS

Structure: Steel with cathoretic coating process with polyester paint.

Top: HPL.

Legs: Iroko wood.

Net: Coated polyester fabric.

Includes: Net / Paddles set (2 units) / Balls set (6 units).

🏠 Structure & Top



WHITE



BLACK

Standard

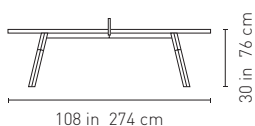

WEIGHT
220.5 lb / 100 kg

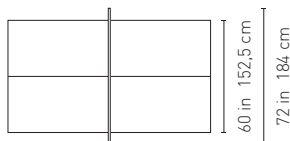

220-Medium

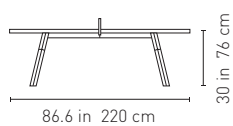

WEIGHT
165 lb / 75 kg

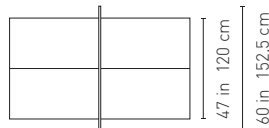

180-Small

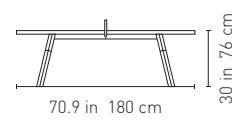

WEIGHT
121 lb / 55 kg

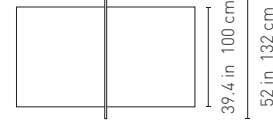

TABLES - INDOOR



MATERIALS

Structure: Steel with cathoretic coating process with polyester paint.

Top: Walnut or oak wood.

Legs: Walnut or oak wood.

Net: Coated polyester fabric.

Includes: Net / Paddles set (2 units) / Balls set (6 units).

🏠 Structure



WHITE



BLACK

Top



WALNUT



OAK

Standard

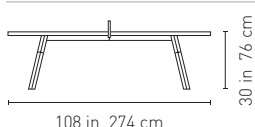

WEIGHT
264.6 lb / 120 kg

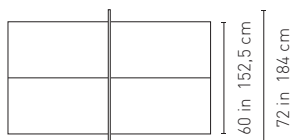

220-Medium

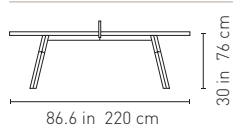

WEIGHT
220.5 lb / 100 kg

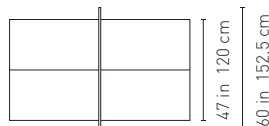

180-Small

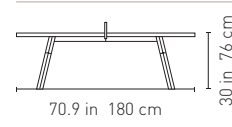

WEIGHT
154.3 lb / 70 kg

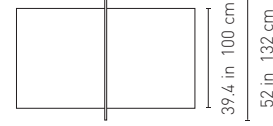

IROKO BENCHES - INDOOR/OUTDOOR



MATERIALS

Structure: Steel with cataphoretic coating process with polyester paint.
Seat: Iroko wood.

Iroko wood finish recommended for walnut and HPL finish tables.

Structure



WHITE



BLACK

Seat



IROKO

285-Bench

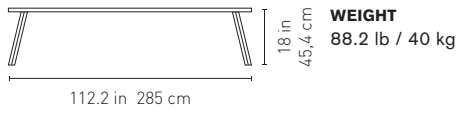

220-Bench



180-Bench

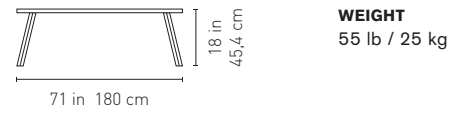

160-Bench

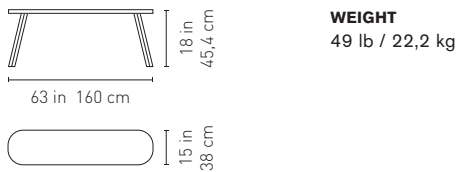

120-Bench

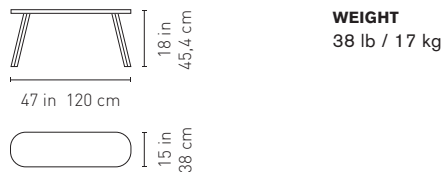

50-Stool



BENCHES - INDOOR



MATERIALS

Structure: Steel with cataphoretic coating process with polyester paint.
Seat: Oak wood.

Structure



WHITE



BLACK

Seat



OAK

220-Bench

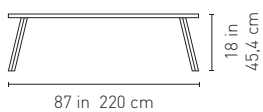

180-Bench

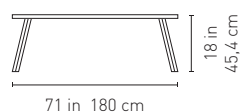

120-Bench

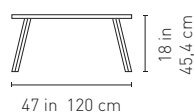

50-Stool

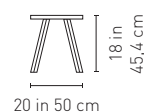

OAK BENCHES - CUSHIONS

MATERIALS

Indoor upholstery: Uniform Mélange from Kvadrat (68% wool, 22% polyamide, 10% polyester).

Outdoor upholstery: Natté from Sunbrella (100% acrylic).



Kvadrat

Sunbrella



0103



0193



WHITE



DARK TAUPE

285

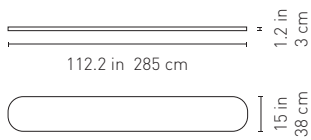

WEIGHT
5.8 lb / 2,6 kg

220

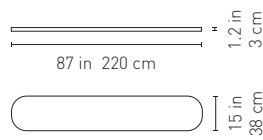

WEIGHT
4.4 lb / 2 kg

180

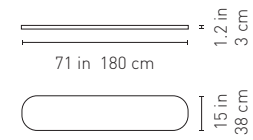

WEIGHT
3.6 lb / 1,6 kg

160

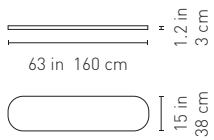

WEIGHT
3.1 lb / 1,4 kg

120

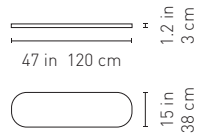

WEIGHT
2.4 lb / 1 kg

50

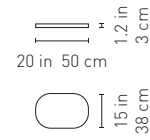

WEIGHT
1 lb / 0,45 kg

SUGGESTED SETS

Standard table

- 1 — Standard table
- 2 — 220 benches
- 2 — 120 benches
- 2 — 50 stools

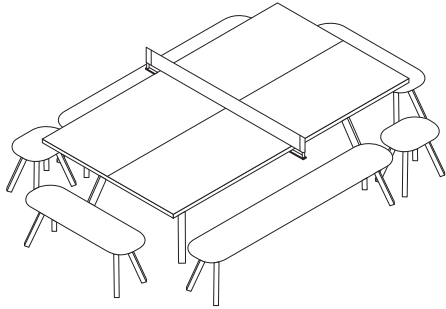

- 1 — Standard table
- 6 — 120 benches

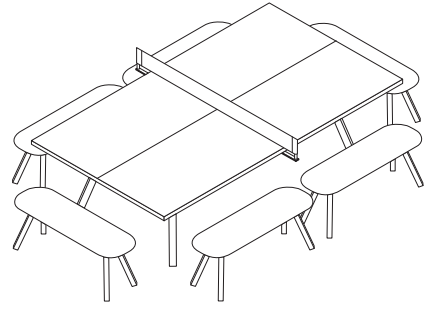

220-Medium table

- 1 — 220-Medium table
- 2 — 220 benches
- 2 — 120 benches

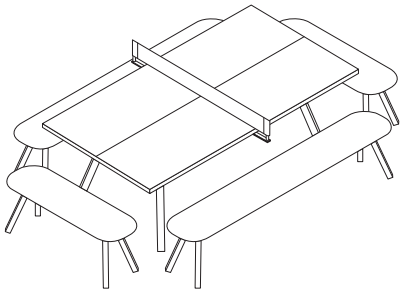

- 1 — 220-Medium table
- 2 — 220 benches
- 4 — 50 stools

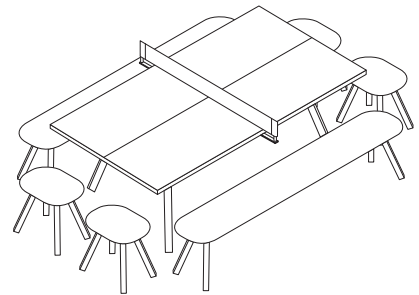

180-Small table

- 1 — 180-Small table
- 2 — 180 benches
- 2 — 50 stools

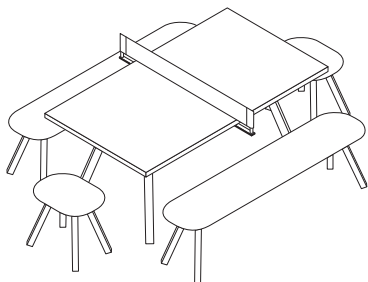

- 1 — 180-Small table
- 2 — 120 benches
- 4 — 50 stools

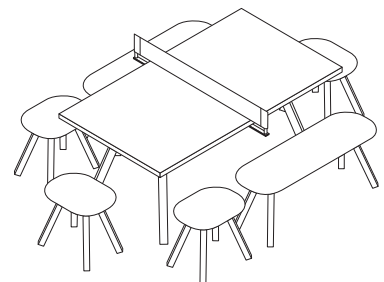

RS#PING-PONG

BY RAFAEL RODRÍGUEZ, 2017

STATIONARY



MATERIALS

Structure: Steel with cathoretic coating process with polyester paint.

Top: HPL.

Legs: Iroko wood.

Net: Coated polyester fabric.

Includes: Net / Paddles set (2 units) / Balls set (6 units).



WHITE



BLACK

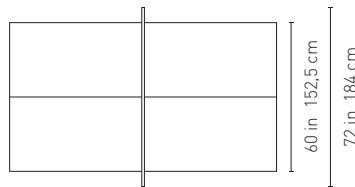
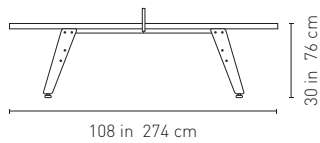

WEIGHT

242.5 lb / 110 kg

FOLDING



MATERIALS

Structure: Steel with cathoretic coating process with polyester paint.

Top: HPL.

Legs: Iroko wood.

Net: Coated polyester fabric.

Includes: Net / Paddles set (2 units) / Balls set (6 units).



WHITE



BLACK

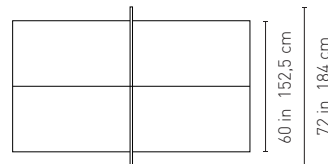
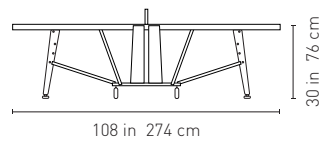
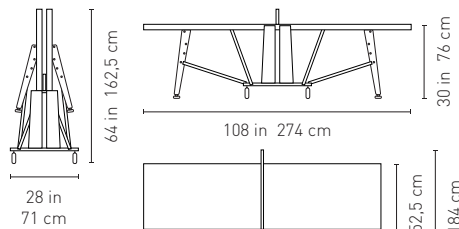

WEIGHT

264.5 lb / 120 kg

PING-PONG ACCESSORIES



BALLS
6 units set



PADDLES
2 units set



FLOOR ANCHORING SYSTEM



PROTECTIVE COVER



WHEELS
4 units set

FOOTBALL TABLES

RS#2

BY RAFAEL RODRÍGUEZ, 2006

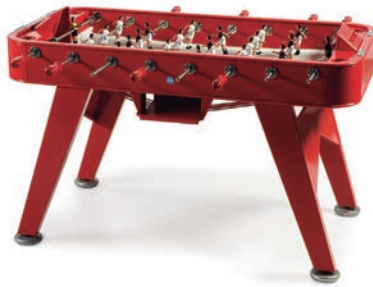

Includes: Balls set (7 units) /
2 extra players (1 per team).



INOX



RAL 9005



RAL 9010



RAL 3020



RAL 3015



RAL 5013



RAL 6011



RAL 7035

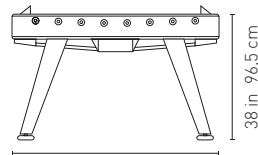

59 in 150 cm

38 in 96.5 cm

WEIGHT

198.5 lb / 90 kg

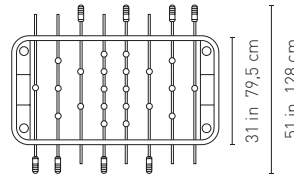

31 in 79.5 cm

51 in 128 cm

Outdoor

MATERIALS

INOX finish: Shot blasted stainless steel lacquered.

RAL colour finish: Stainless steel structure with powder coated polyester paint.

Field: HPL.

Players: Cast aluminium.

Handles: Wood with polyester paint.

Indoor

MATERIALS

RAL colour finish: Steel structure with powder coated polyester paint.

Field: HPL.

Players: Cast aluminium.

Handles: Wood with polyester paint.

RS#3 WOOD

BY RAFAEL RODRÍGUEZ, 2012



MATERIALS

INOX finish: Shot blasted stainless steel lacquered.

RAL colour finish: Steel with cataphoretic coating process with powder coated polyester paint.

Field: HPL.

Players: Cast aluminium.

Handles: Iroko wood.

Legs: Iroko wood.

Includes: Balls set (7 units) / 2 extra players (1 per team).



INOX



RAL 9010



RAL 9005



RAL 6011

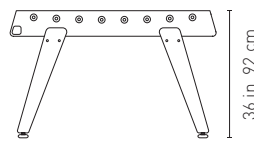

59.5 in 151 cm

36 in 92 cm

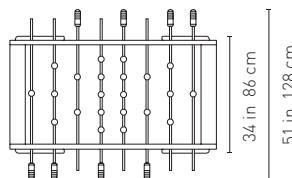

34 in 86 cm

51 in 128 cm

WEIGHT

159 lb / 72 kg

RS#3

BY RAFAEL RODRÍGUEZ, 2011



MATERIALS

RAL colour finish: Steel with cataphoretic coating process with powder coated polyester paint.

Field: HPL.

Players: Cast aluminium.

Handles: Wood with polyester paint.

Includes: Balls set (7 units) / 2 extra players (1 per team).



RAL 9010



RAL 3020



RAL 5012



RAL 1021



RAL 9005



RAL 6011
RS3-6

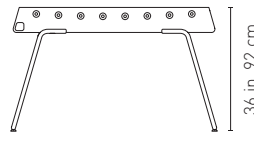

59.5 in 151 cm

36 in 92 cm

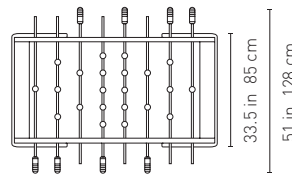

33.5 in 85 cm

51 in 128 cm

WEIGHT

163 lb / 74 kg

GOLD EDITION

RS#2 GOLD

BY RAFAEL RODRÍGUEZ, 2016



MATERIALS

Structure: Stainless steel with polyester paint.

Field: HPL.

Players: Cast aluminium in gold and silver chrome plating.

Handles: Wood with polyester paint.

24k gold plated details: The score counter, ball bearing, screws and other small pieces.

Includes: Balls set (7 units) / 2 extra players (1 per team).



RAL 9010



RAL 9005

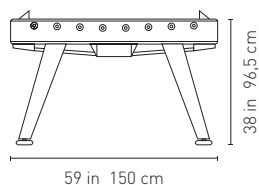

WEIGHT

198.5 lb / 90 kg

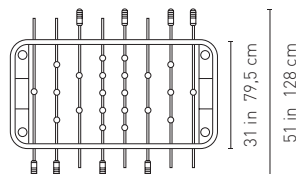

RS#3 WOOD GOLD

BY RAFAEL RODRÍGUEZ, 2016



MATERIALS

Structure: Steel with cathoretic coating process with polyester paint.

Legs: Iroko wood.

Field: HPL.

Players: Cast aluminium in gold and silver chrome plating.

Handles: Iroko wood.

24k gold plated details: The score counter, ball bearing, screws and other small pieces.

Includes: Balls set (7 units) / 2 extra players (1 per team).



RAL 9005

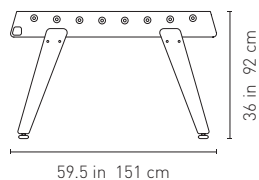

WEIGHT

159 lb / 72 kg

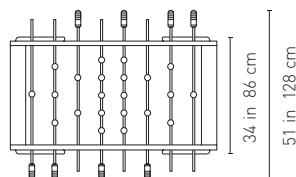

RS#2 DINING

BY JOSÉ ANDRÉS AND RAFAEL RODRÍGUEZ, 2014

LOW-OVAL

Includes: Balls set (7 units) / 2 extra players (1 per team).

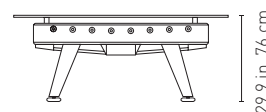
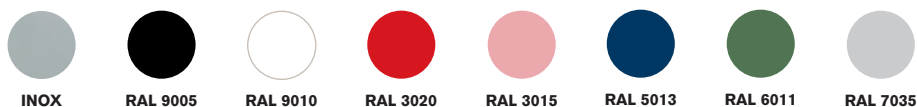

Outdoor

MATERIALS

INOX finish: Shot blasted stainless steel lacquered.
RAL colour finish: Stainless steel structure with powder coated polyester paint.
Glass: 0.6 in/1,5 cm template glass.
Field: HPL.
Players: Cast aluminium.

Indoor

MATERIALS

RAL colour finish: Steel structure with powder coated polyester paint.
Field: HPL.
Glass: 0.6 in/1,5 cm template glass.
Players: Cast aluminium.
Handles: Wood with polyester paint.

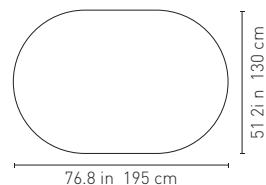

WEIGHT
439 lb / 199 kg

LOW-RECTANGULAR

Includes: Balls set (7 units) / 2 extra players (1 per team).

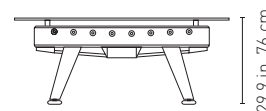
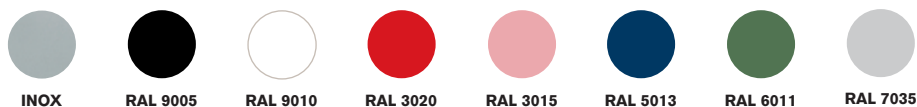

Outdoor

MATERIALS

INOX finish: Shot blasted stainless steel lacquered.
RAL colour finish: Stainless steel structure with powder coated polyester paint.
Glass: 0.6 in/1,5 cm template glass.
Field: HPL.
Players: Cast aluminium.

Indoor

MATERIALS

RAL colour finish: Steel structure with powder coated polyester paint.
Field: HPL.
Glass: 0.6 in/1,5 cm template glass.
Players: Cast aluminium.
Handles: Wood with polyester paint.

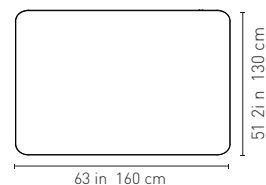

WEIGHT
439 lb / 199 kg

TALL-OVAL



Includes: Balls set (7 units) /
2 extra players (1 per team).



INOX



RAL 9005



RAL 9010



RAL 3020



RAL 3015



RAL 5013



RAL 6011



RAL 7035

Outdoor

MATERIALS

INOX finish: Shot blasted stainless steel lacquered.

RAL colour finish: Stainless steel structure with powder coated polyester paint.

Glass: 0.6 in/1,5 cm template glass.

Field: HPL.

Players: Cast aluminium.

Indoor

MATERIALS

RAL colour finish: Steel structure with powder coated polyester paint.

Field: HPL.

Glass: 0.6 in/1,5 cm template glass.

Players: Cast aluminium.

Handles: Wood with polyester paint.

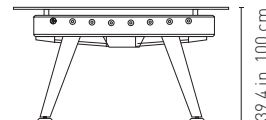

39.4 in 100 cm

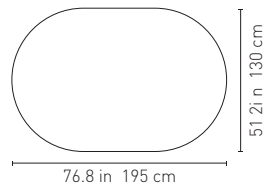

76.8 in 195 cm

51.2 in 130 cm

WEIGHT

439 lb / 199 kg

TALL-RECTANGULAR



Includes: Balls set (7 units) /
2 extra players (1 per team).



INOX



RAL 9005



RAL 9010



RAL 3020



RAL 3015



RAL 5013



RAL 6011



RAL 7035

Outdoor

MATERIALS

INOX finish: Shot blasted stainless steel lacquered.

RAL colour finish: Stainless steel structure with powder coated polyester paint.

Glass: 0.6 in/1,5 cm template glass.

Field: HPL.

Players: Cast aluminium.

Indoor

MATERIALS

RAL colour finish: Steel structure with powder coated polyester paint.

Field: HPL.

Glass: 0.6 in/1,5 cm template glass.

Players: Cast aluminium.

Handles: Wood with polyester paint.

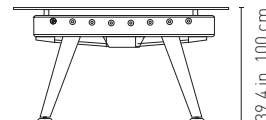

39.4 in 100 cm



63 in 160 cm

51.2 in 130 cm

WEIGHT

439 lb / 199 kg

RS#3 WOOD DINING

BY JOSÉ ANDRÉS AND RAFAEL RODRÍGUEZ, 2020



MATERIALS

Structure: Steel with cathoretic coating process with polyester paint.
Inox structure: Stainless steel.
Glass: 0.4 in / 1 cm template glass.
Field: HPL.
Players: Cast aluminium.
Handles: Wood with polyester paint.
Legs: Iroko wood.

INCLUDES:

Balls set (7 units)
 2 extra players (1 per team).

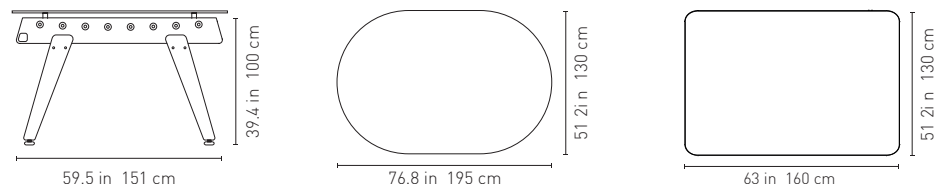

PRODUCT WEIGHT
 439 lb / 199 kg

RS# PLAYERS CUSTOMISATION

TWO FEET



ONE FOOT



Choose the player that best suits your kind of play.

Girl players only available with two feet.

FOOTBALL TABLE ACCESSORIES

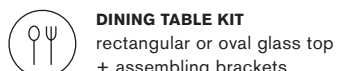

B-AROUND

BY ANTONI PALLEJÀ OFFICE, 2019



MATERIALS

Structure: Steel with cataphoretic coating process and polyester paint.
Top: Iroko wood or marble.

Product options: Ask for power socket options.

All sizes available in 25.6 in / 65 cm width and 41.3 in / 105 cm height.

Structure



WHITE



BLACK

Iroko top



IROKO

Marble top



WHITE CARRARA



BLACK MARQUINA

ONLY FOR 65 SQUARE AND 65 ROUND SIZES

285

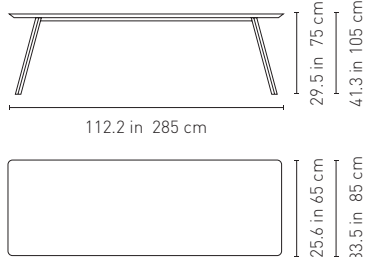

220

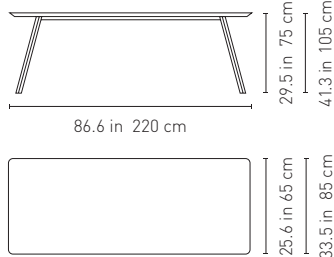

180

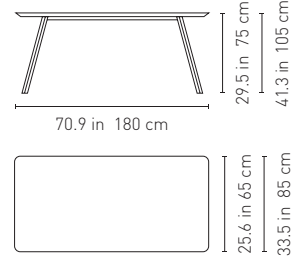

160

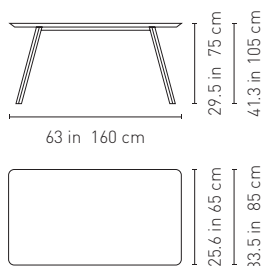

120

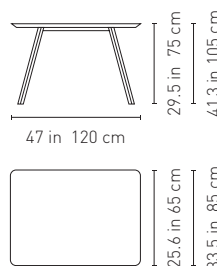

120 SQUARE

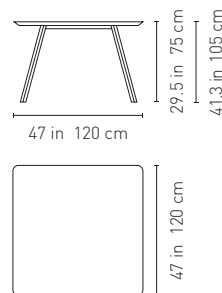

100 SQUARE

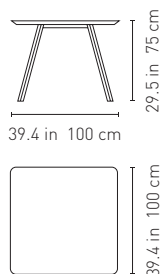

85 SQUARE

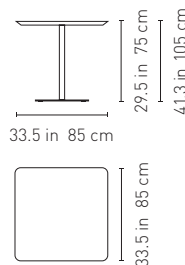

65 SQUARE

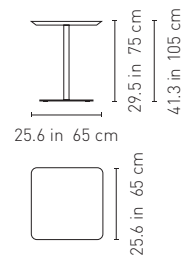

120 ROUND

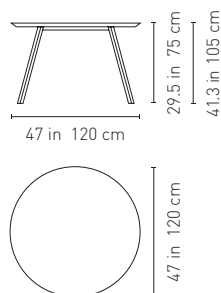

100 ROUND

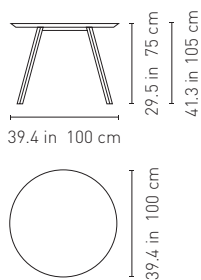

85 ROUND

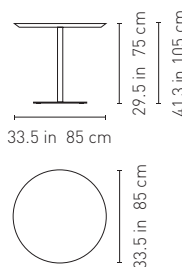

65 ROUND

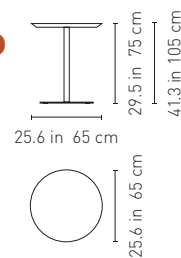

OMBRA

BY EMILIANA DESIGN STUDIO, 2019



MATERIALS

Steel with cataphoretic coating process with a micro textured polyester paint. Stainless steel for the inox finish.

Product options: With or without backrest.



RAL 9016



RAL 9005



RAL 3013



RAL 6011



RAL 1013



INOX

BAR

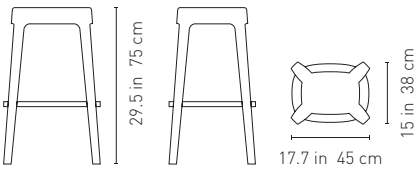

WEIGHT
19.6 lb / 8,9 kg

BAR WITH BACKREST

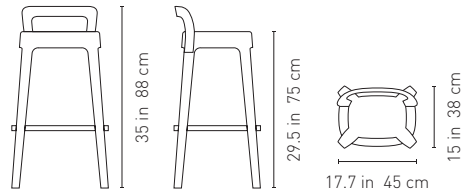

WEIGHT
20.9 lb / 9,5 kg

COUNTER

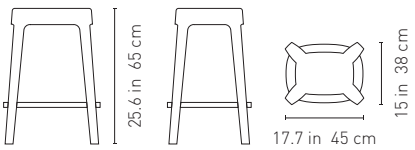

WEIGHT
17.9 lb / 8,1 kg

COUNTER WITH BACKREST

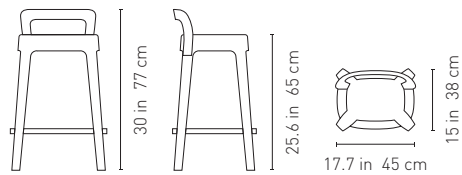

WEIGHT
19 lb / 8,7 kg

LOW

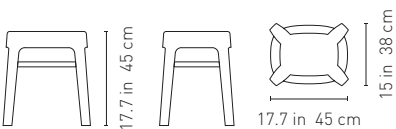

WEIGHT
13.2 lb / 6 kg

LOW WITH BACKREST



WEIGHT
14.5 lb / 6,6 kg

PLEC

BY ANTONI PALLEJÀ OFFICE, 2017



MATERIALS

Steel with cataphoretic coating process with polyester micro textured paint.

Top: Steel or marble.

Product options: Steel legs and top or steel legs and marble top.

Steel

Marble



RAL 9016



RAL 9005



RAL 3013



RAL 6000



WHITE CARRARA



BLACK MARQUINA



GREEN AVER



RED FRANCIA

LARGE

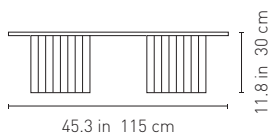

STEEL

WEIGHT
52.5 lb / 23,8 kg



MARBLE

WEIGHT
92.6 lb / 42 kg

MEDIUM

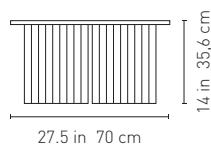

STEEL

WEIGHT
45.2 lb / 20,5 kg

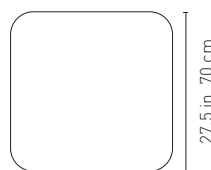

MARBLE

WEIGHT
75 lb / 34 kg

SMALL

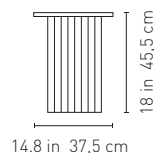

STEEL

WEIGHT
18.3 lb / 8,3 kg



MARBLE

WEIGHT
25.6 lb / 11,6 kg

SUGGESTED SETS

Set 1

- 1 — Plec large
- 1 — Plec medium

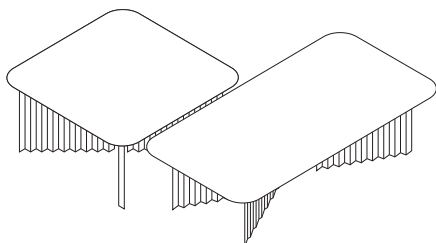

Set 2

- 1 — Plec medium
- 1 — Plec small

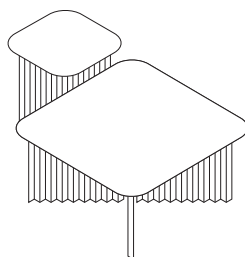

Set 3

- 1 — Plec large
- 1 — Plec small

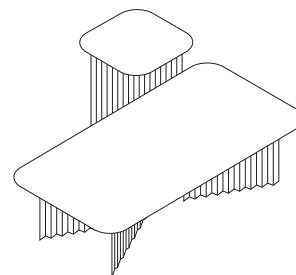

ON THE ROAD

BY STONE DESIGNS, 2008



MATERIALS

Structure: Cross-ply beech base with solid beech legs.

Upholstery: Uniform Mélange from Kvadrat (68% wool, 22% polyamide and 10% polyester).

Strap: 100% polyester.

Stuffing: Mix of natural and synthetic fibres.

🏠 Kvadrat



0983



0193



0133

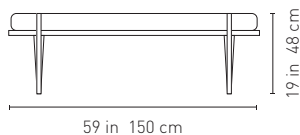

WEIGHT

28.7 lb / 13 kg

BY YOURSHELF

BY STONE DESIGNS, 2008

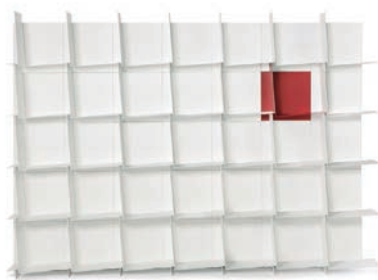

MATERIALS

Steel coated with polyester paint in a lightly textured finish.



RAL 3020



RAL 9005



RAL 9016



RAL 7035

STANDARD MODULE

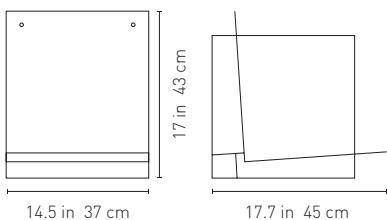

WEIGHT
19.8 lb / 9 kg

OPEN MODULE

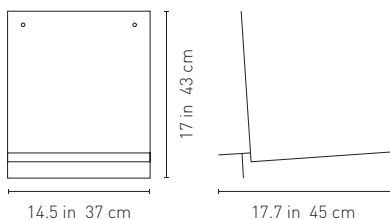

WEIGHT
13.9 lb / 6,3 kg

MODULE WITH TRIM PANEL

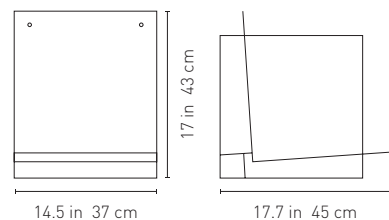

WEIGHT
24.2 lb / 11 kg

SUGGESTED SETS

Set 1 (5x5)

25 — Standard modules

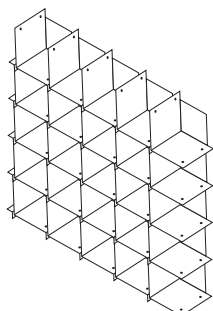

Set 2 (5x2)

10 — Modules with trim panel

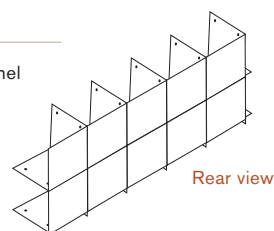

ACCESSORIES

WALL CHAMPIONS

BY RAFAEL RODRÍGUEZ, 2007

WCH1



MATERIALS
Player: Cast aluminium.

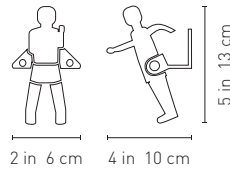

WEIGHT
 0.7 lb / 0,3 kg

WCH4



MATERIALS
Player: Cast aluminium.
Rod: Satin finish steel + wooden handle.

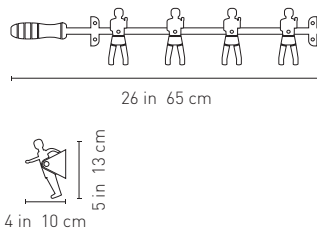

WEIGHT
 4.5 lb / 2 kg



ARGENTINA BLUE-RED FRANCE GERMANY ITALY NETHERLANDS SPAIN BRAZIL ENGLAND WHITE USA GOLD SILVER

WOOD CHAMPIONS

BY RAFAEL RODRÍGUEZ, 2017

MATERIALS

Player: Beech wood.

Rod: Satin finish steel + beech wood handle.

It comes with stickers to customize the players.

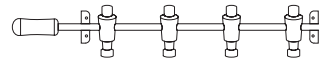

26 in 65 cm

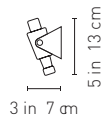

3 in 7 cm

5 in 13 cm

WEIGHT

4.5 lb / 2 kg

MON ONCLE

BY MERMELADA STUDIO, 2014

MATERIALS

Structure: Steel with polyester matt paint finish.

Grill: Stainless steel.

Inside tray: Stainless steel.

Strap: Fabric and leather handle.



RAL 5024



RAL 6021



RAL 7016



RAL 1013

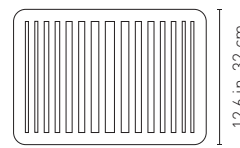

17.3 in 44 cm

12.6 in 32 cm

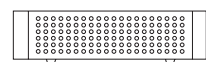

5.3 in 13.6 cm

WEIGHT

13.9 lb / 6,3 kg

EIFFEL

BY SHIGEKI FUJISHIRO, 2012

PAPER



MATERIALS

Structure: Recycled paper pulp.

It comes with a flat pack and a recycled cotton bag.



ANTHRACITE

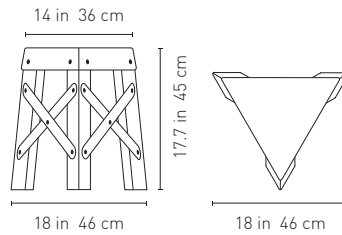

WEIGHT

3.3 lb / 1,5 kg

ALUMINIUM



MATERIALS

Structure: Aluminium painted with polyester paint.

It comes with a flat pack and a recycled cotton bag.



RAL 9010



RAL 9005



RAL 3020



RAL 5012



RAL 1021



RAL 3015

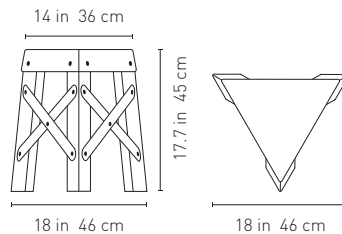

WEIGHT

4.4 lb / 2 kg

KIDS



MATERIALS

Structure: Aluminium painted with polyester paint.

It comes with a flat pack and a recycled cotton bag.



RAL 9010



RAL 3020



RAL 5012



RAL 1021



RAL 3015

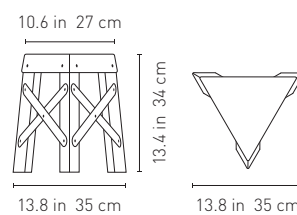

WEIGHT

3.3 lb / 1,5 kg



Concept, graphic design
and copywriting:
Doctor Magenta

Photography:
Meritxell Arjalaguer

Except p. 28, 48 and 49 by
Joan Cabacés

And p. 28 by
Ken Wyner

Printing:
9disseny

Thanks to:
Hotel Alexandra Barcelona
Genialidades

Head Office

C. Còrsega, 365, Principal 2ª
08037 Barcelona — Spain
Phone +34 936 589 503
info@rs-barcelona.com

Showroom

C. Còrsega, 365
08037 Barcelona — Spain
Phone +34 936 589 503
info@rs-barcelona.com

Factory

C. Ferrocarril, 16
08840 Viladecans
Barcelona — Spain

Warehouse

C. Noi del Sucre, 3
08840 Viladecans
Barcelona — Spain



www.rs-barcelona.com

